



GE15-DO

Spherical plain bearing

Schaeffler ID:
0066479790000

Radial spherical plain bearing, requiring maintenance, sliding contact surface: steel/steel, DIN ISO 12240-1, dimension series E, open design

Technical information

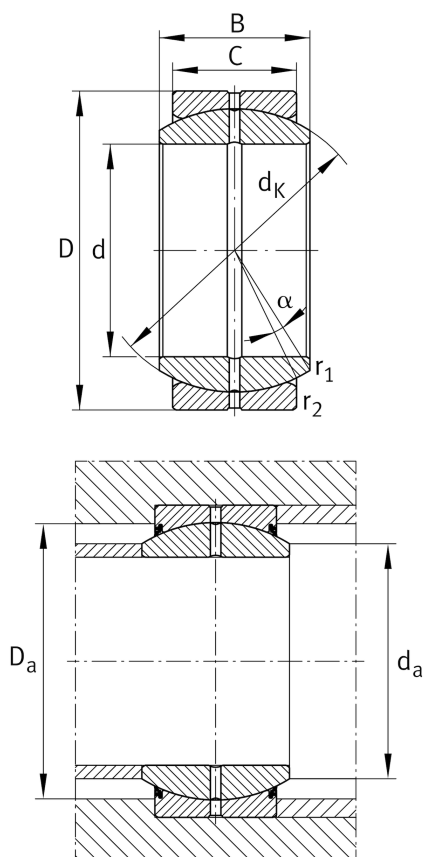

Main Dimensions & Performance Data

d	15 mm	Bore diameter bearing
D	26 mm	Outside diameter bearing
B	12 mm	Width Inner ring
C _r	16,900 N	Basic dynamic load rating, radial
C _{0r}	84,700 N	Basic static load rating, radial
	0.026 kg	Weight

Dimensions

C	9 mm	Width Outer ring
d _K	22 mm	Ball diameter
α	8 °	Tilt angle
r _{1smin}	0.3 mm	Edge Spacing
r _{2smin}	0.3 mm	Edge Spacing
d _{OT}	0 mm	Bore diameter bearing, upper tolerance
d _{UT}	-0.008 mm	Bore diameter bearing, lower tolerance
D _{OT}	0 mm	Outside diameter, upper tolerance
D _{UT}	-0.009 mm	Outside diameter, lower tolerance
B _{OT}	0 mm	Width inner ring, upper tolerance
G _r	0,04 - 0,082 mm	Radial Clearance
B _{UT}	-0.12 mm	Width inner ring, lower tolerance
C _{OT}	0 mm	Width outer ring, upper tolerance

Mounting dimensions

d _{a max}	18.4 mm	Connection measure Inner ring
D _{a min}	21 mm	Housing Connection Diameter

Temperature range

T _{min}	-60 °C	Operating temperature min.
T _{max}	200 °C	Operating temperature max.